

REVISIONS				
ZONE	REV	DESCRIPTION	Date	APPROVED

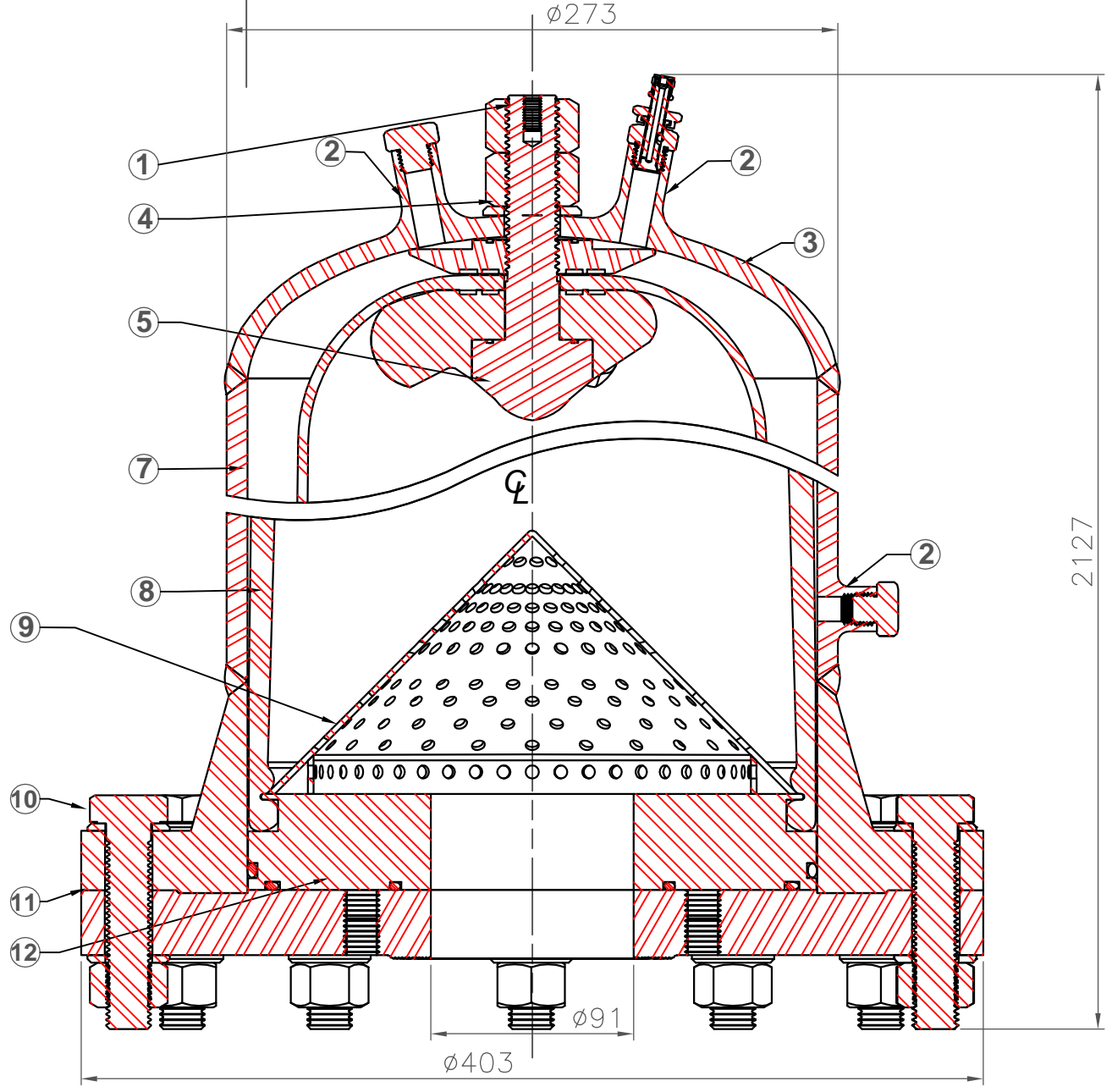

Item	Description	Material	Heat #
12	Closure/manway, bladder loading	Carbon Steel	
11	Vessel open end and flange	Carbon Steel	
10	Closure bolting 3/8", 12 pieces	316/316L	
9	Perforated cone	316/316L	
8	Bladder	Nitrile	
7	Vessel shell cylinder	Carbon Steel	
5	Bladder small end anchor	316/316L	
4	Lock nuts for bladder small end anchor	316/316L	
3	2:1 S.E. Head	316/316L	
2	Bladder permeation/leakage detection/air/nitrogen inlet	Carbon Steel	
1	Bladder installation pull through rod connection thread M12	316/316L	

PulseGuard INC. LTD.

SuG-26G-275p-3" 150#RF

SIZE	FSCM NO.	DWG NO.	REV
Scale 35%		Sheet	